



CV600 Spectrometer

User Manual and Warranty

Please read the operating manual carefully to fully understand the features of this product before use and keep it for future use. Keep the operating manual in a safe place.

Contents

1	CV600 Introduction	1
	1.1 Packing Contents	2
	1.2 Appearance Introduction	3
	1.3 Product Features	4
	1.4 Annual Product Calibration	5
	1.5 Product Notes and Precautions	6
2	Preparing Before Use	7
	2.1 Battery Installation and Charging	8
	2.2 Memory Card Installation	10
	2.3 Strap and Neck Strap Installation	11
	2.4 Screen Wiper Usage Method	12
	2.5 Power On / Off	13
	2.6 Dark Calibration	14
	2.7 Option Function Setting	16
	2.8 System Reset	18
3	System Overview	19
	3.1 Measurement Modes Introduction	20
	3.2 Measurement Introduction	23
	3.3 Measurement Setting Introduction	25
	3.4 Continuous Measurement Introduction	27
	3.5 Customizing BASIC Mode List	28
	3.6 CRI Mode	29

Contents

3.7	FILTER Mode Introduction	30
3.8	FLICKER Mode	32
3.9	FLICKER Mode Judgment Mechanism	33
3.10	EXPOSURE Mode	35
3.11	BROWSER Mode Introduction	40
3.12	Transferring Data with PC Connection	41
4	Specification	43
4.1	Product Specification	44
5	Appendix Warranty	
5.1	Product Warranty	



For more operation & firmware update information, please visit www.uprtek.com

CV600 Introduction

A large, stylized number '1' is positioned to the right of the main title. It consists of a vertical stem and a diagonal top bar that extends to the left and then turns down to meet the stem. Below the title and the number, there is a thick horizontal grey bar that spans across the page.

- 1.1 Packing Contents
- 1.2 Appearance Introduction
- 1.3 Product Features
- 1.4 Annual Product Calibration
- 1.5 Product Notes and Precautions

1.1 Packing Contents

Please check CV600 packing before use, contact your agent if there are missing items.



Case



CV600
LED Meter



Protection Bag



Battery



USB Cable

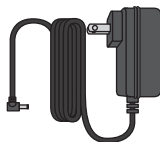

Power Adaptor



Screen Wiper



Strap



Neck Strap



User Manual
and Warranty



Stand Bracket

1.2 Appearance Introduction

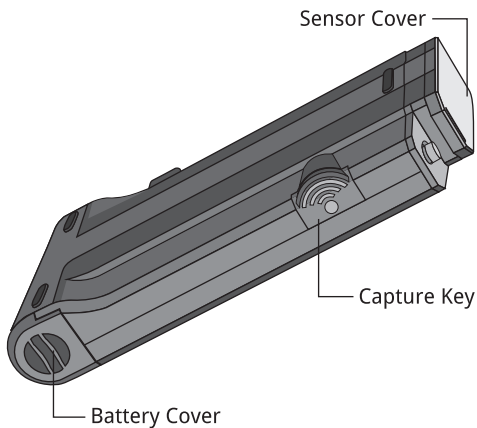
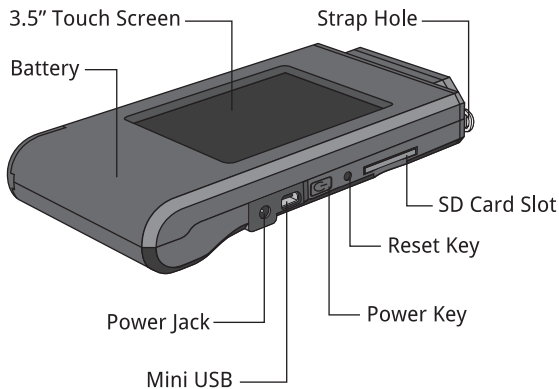

1.3 Product Features

1. 3.5" touch panel, easy to measure at any time.
2. With white balance correction for photography, capable of adjusting and choosing the correct filter based on different color temperatures.
3. Flicker detection sampling rate up to 100KHz/ sec, showing both percent flicker and flicker index.
4. Built-in flicker free function, enable the setting between camera frame rate and light source frequency to provide flicker-free shooting environment.
5. With light meter function, showing environmental lux and also the relevant relation among shutter, aperture and ISO.
6. SD card storage, easy to transfer data.

1.4 Annual Product Calibration

This product is a high-precision measurement device with sensitive, please use with care. To ensure the accuracy of measurements, it is recommended to have the unit calibrated once a year. Please contact your agent or our customer service department for calibration service.

1.5 Product Notes and Precautions

1. The CV600 LED Meter contains sensitive components. Please unpack with care, as any trauma to the unit may damage the equipment. Contact your agent if the unit appears not to be operating normally. Do not attempt any repairs – all repairs must be performed by qualified service agents.
2. Most LCD screens have a very small and inconsequential defective pixel rate (usually less than 0.1%). This results in occasional pinpoints of white or other colors but will not affect the accuracy of measurements.



Precautions / Warnings

Please read the following precautions to avoid fire, excessive heat, chemical leakage and explosion.

- ◆ Do not disassemble or modify the battery.
- ◆ Do not expose the battery to heat (fire) or water/moisture.
- ◆ When disposing used/old batteries, wrap with insulation tape to shield the battery from electrical contact with metallic objects, which might ignite a fire or explosion.
- ◆ If the unit is plugged into the power adapter and the battery seems to be overheating, or if there is smoke or peculiar odors emanating from the unit, unplug immediately to avoid the possibility of fire.
- ◆ However, do not touch the cables if there is heat emanating from near the cables as melted or deformed cables could expose wiring and result in burns or electric shock.
- ◆ Do not use cloth or anything to wrap or cover the equipment while charging – this could cause the unit to overheat, melting the casing or causing fire.
- ◆ If the unit is accidentally immersed in water, or if moisture has seeped inside, or metal objects have dropped into the casing, immediately remove the battery to avoid fire or electric shock.
- ◆ Do not operate or store the battery in high-temperature environments - it will cause battery leakage and/or shorten the life of the battery .
- ◆ Do not use paint thinner, benzene or other organic solvents to clean the equipment – this may damage the exterior finish or touch screen, and may even ignite fire.

Preparing Before Use

2

- 2.1 Battery Installation and Charging
- 2.2 Memory Card Installation
- 2.3 Strap and Neck Strap Installation
- 2.4 Screen Wiper Usage Method
- 2.5 Power On / Off
- 2.6 Dark Calibration
- 2.7 Option Function Setting
- 2.8 System Reset

2.1 Battery Installation and Charging

Battery installation :

Step1. Hold CV600 , then press the battery cover.

Step2. Press the battery cover down to remove it.

Step3. Install the battery after removing battery cover.

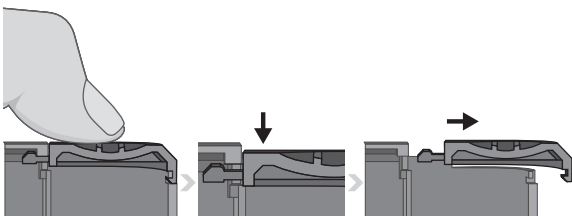
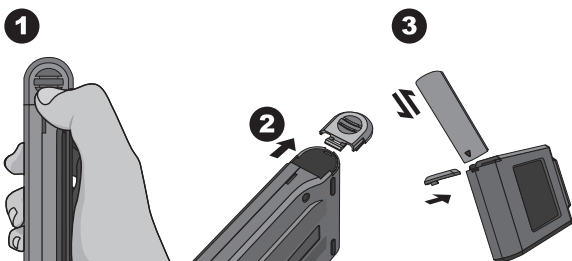

※ Press the battery cover down then you can remove the cover smoothly from CV600.

1. Please charge the battery for 6 hours at first time usage.
2. To avoid any interruption while measuring, please check battery status before use.
3. Please purchase a new battery if it gets low easily after being fully charged, which means battery life comes to an end.
4. Usage time will depends on battery life, CV600 battery can operate 5 hours after being fully charged.



2.1 Battery Installation and Charging

Battery charging :

1. Plug power charging cable into power jack to start charging.
2. Power Off Status: Users can check power key, it will light in red while charging and light off after being fully charged.
3. Power On Status: Users can check CV600 screen, it will appear a lightning symbol to indicate charging, and lightning symbol will disappear after being fully charged.

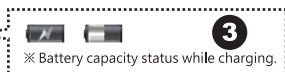
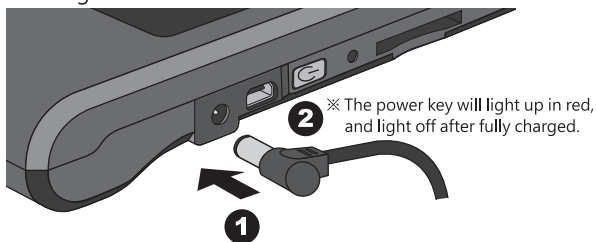

※ Lightning symbol will appear when charging and disappear after being fully charged.

2.2 Memory Card Installation

Installing the SD Card :

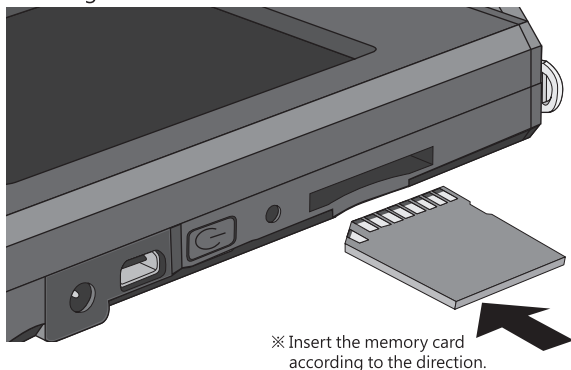

Remove the SD Card :

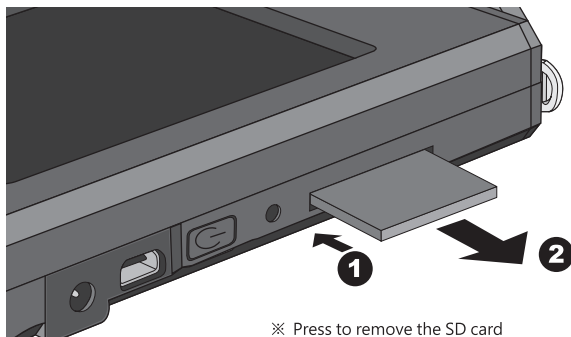

1. Check SD card status, refer 2.7 Storage
2. Check SD card storage method, refer 3.2 Save Measured Data

2.3 Strap and Neck Strap Installation

Strap installation :

Step1. Unscrew the strap

Step2. Tie the strap to the strap hole of CV600

Step3. Tie the strap to the sensor cover

Step4. Screw the strap

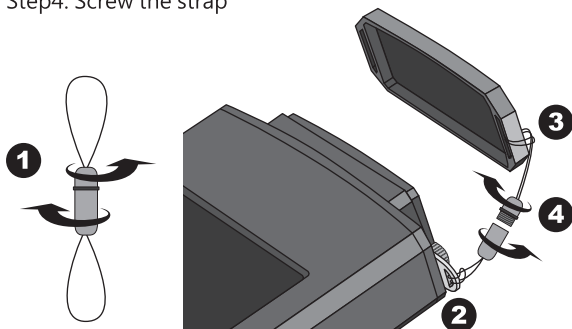

Neck strap installation :

Tie on the strap hole of CV600.

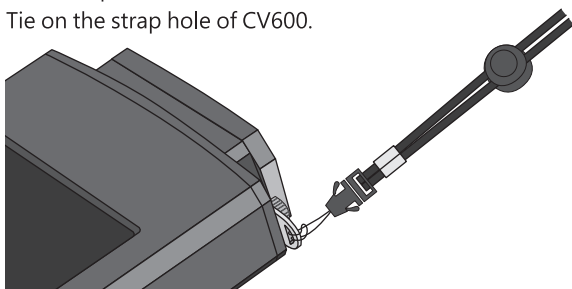

2.4 Screen Wiper Usage Method

1. The wiper can remove the dirt easily.
2. Strong absorbent and no effect after repeated washing.
3. Can use bleach for wash but do not iron the wiper.

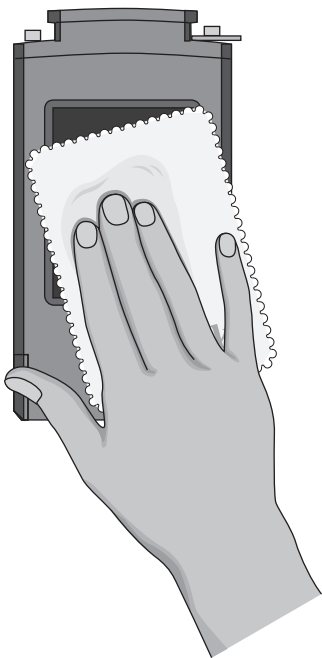

2.5 Power On / Off

Turn on the power : Press the power key for 1 second.

Turn off the power : Press the power key for 5 seconds.

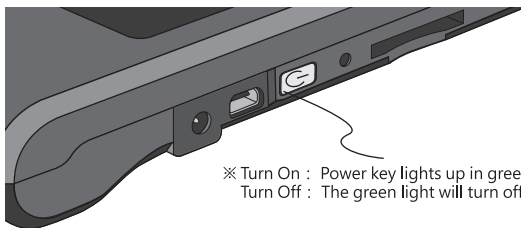

※ Turn On : Power key lights up in green light.
Turn Off : The green light will turn off.

2.6 Dark Calibration

1. After turning on CV600, system will process dark calibration automatically.

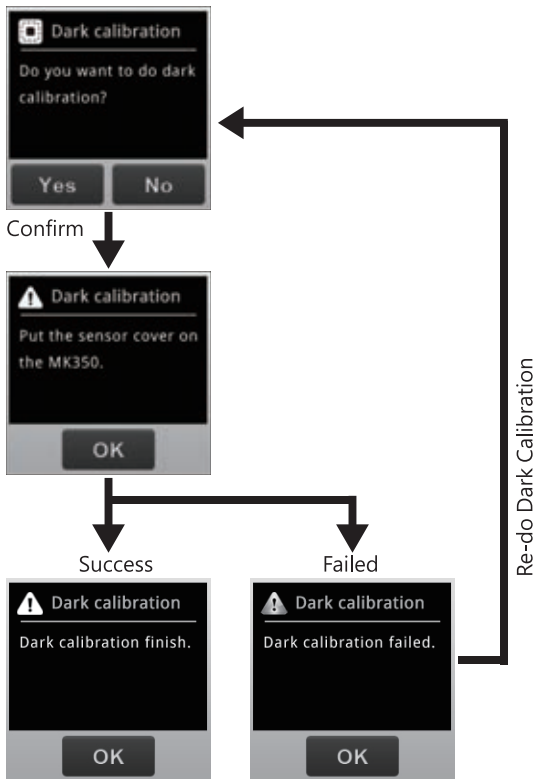

1. Suggest to execute dark calibration every time when turning on CV600.

2.6 Dark Calibration

2. When using CV600, users can execute dark calibration manually.

Users can go to measurement page, then select MEASUREMENT SETTING --> DARK CALIBRATION to execute dark calibration manually.

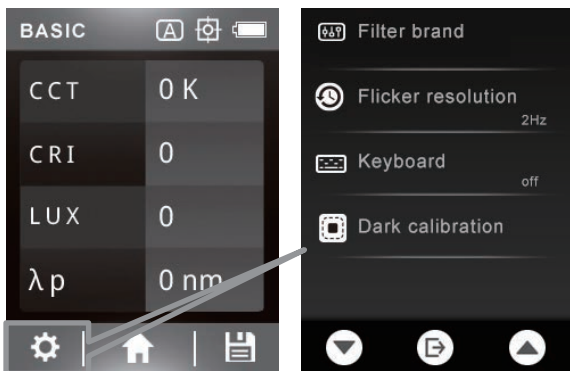

2.7 Option Function Setting

Go to main menu and select OPTION to start system setting.

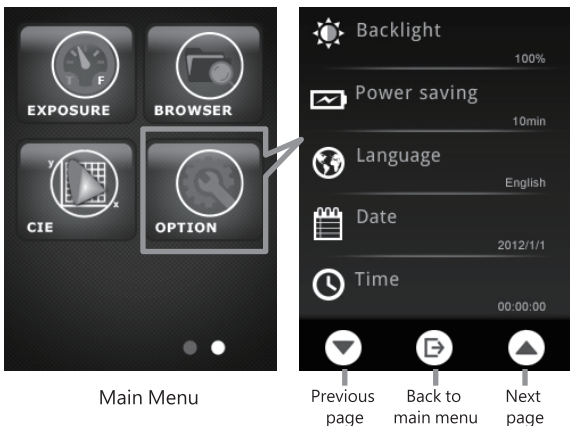

Backlight Setting :

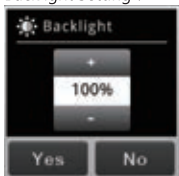

Power Saving Setting :



Language Setting :



Date Setting :

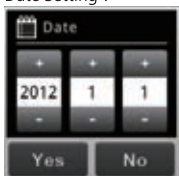

Time Setting :

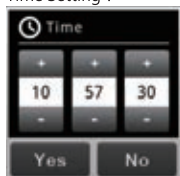

+ / - : Adjust key
Yes / No : End of the setting

2.7 Option Function Setting

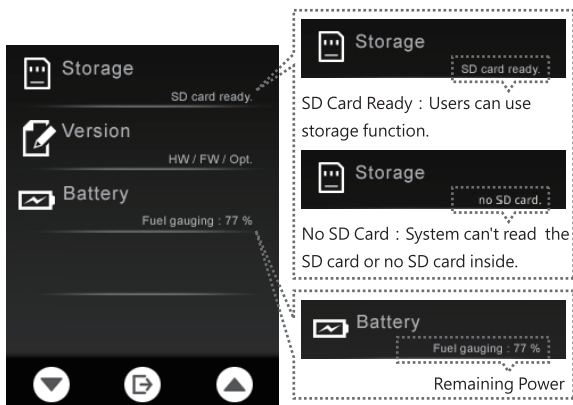

Check Storage Device :

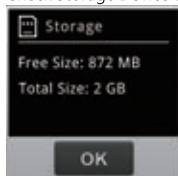

Check Version :



1. Please set up date and time before saving the files.
2. Users can set up auto power-off time to save battery power. Default auto power-off setting is 10 minutes.

2.8 System Reset

Users can press the reset key to turn off the system if system crashes.

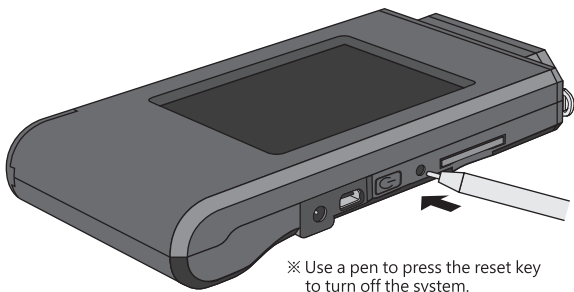
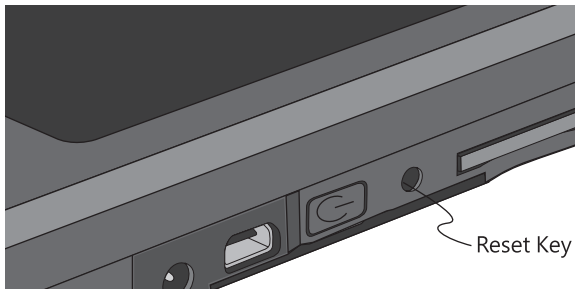

3

System Overview

- 3.1 Measurement Modes Introduction
- 3.2 Measurement Introduction
- 3.3 Measurement Setting Introduction
- 3.4 Continuous Measurement Introduction
- 3.5 Customizing BASIC Mode List
- 3.6 CRI Mode
- 3.7 FILTER Mode Introduction
- 3.8 FLICKER Mode
- 3.9 FLICKER Mode Judgment Mechanism
- 3.10 EXPOSURE Mode
- 3.11 BROWSER Mode Introduction
- 3.12 Transferring Data with PC Connection

3.1 Measurement Modes Introduction

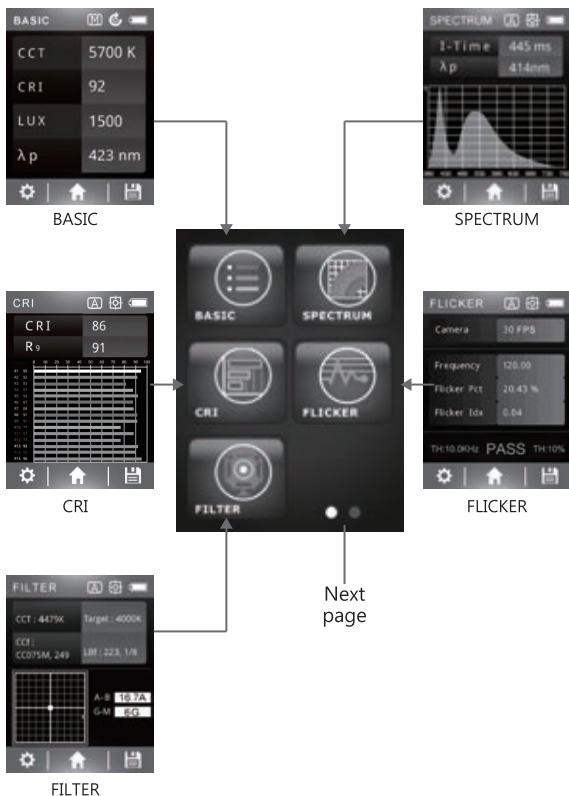

3.1 Measurement Modes Introduction

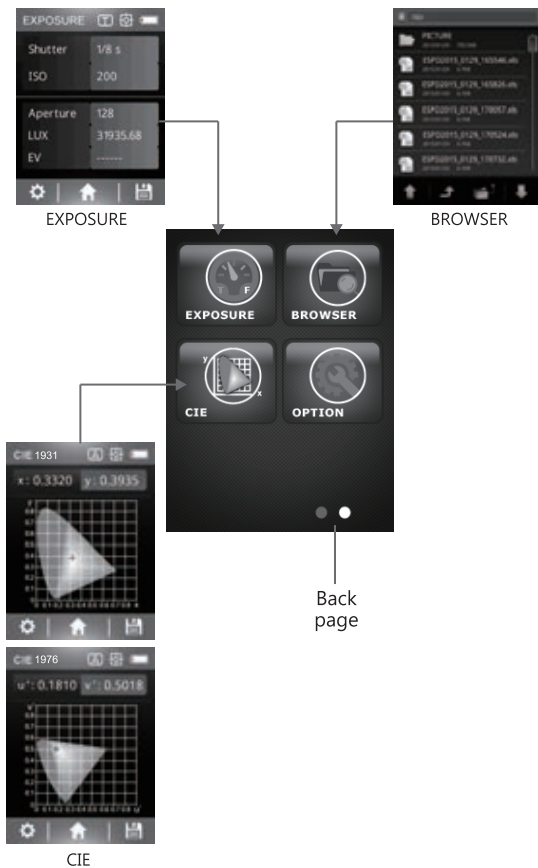

3.1 Measurement Modes Introduction

Interface introduction :



Means button



1. Measurement mode - BASIC / SPECTRUM / CIE1931 / CIE1976
2. Integration mode - Auto **A** / Manual **M**
3. Capture function - One time / Continuous
4. Battery capacity
5. Measurement result
6. Measurement setting
7. Back to main menu
8. Save data

3.2 Measurement Introduction

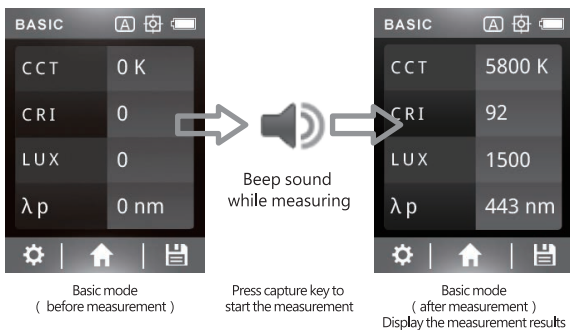
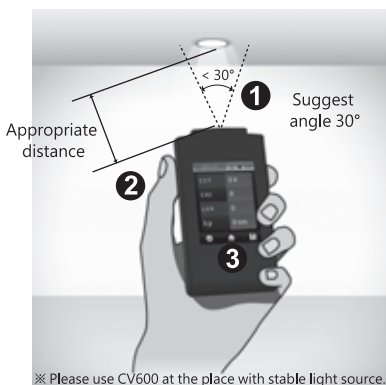

Step 1 : Point sensor head at light source with suggest angle 30°.

Step 2 : At appropriate distance, then press capture key.

Step 3 : After beep sound, measured data will be displayed on the screen.



1. Operation sound setting, refer 3.3 Operation sound

3.2 Measurement Introduction

Save measured data :

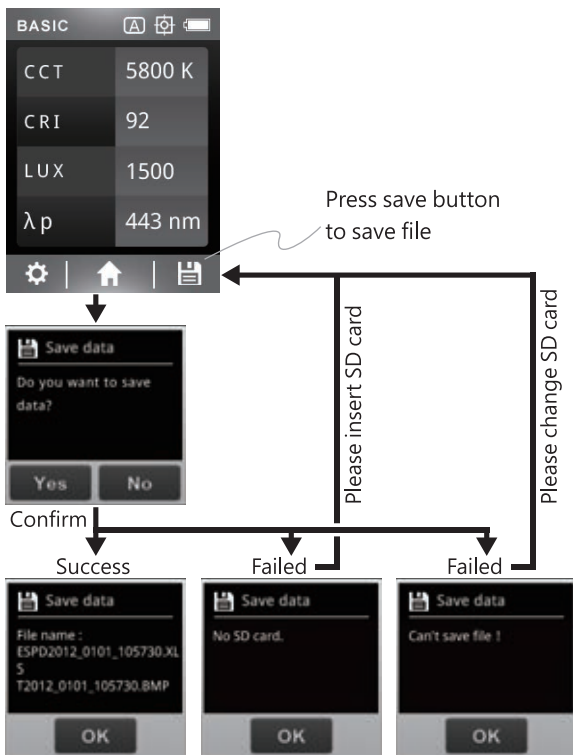

1. Save format setting, refer 3.3 Save format
2. Available capacity of SD card, refer 2.7 Storage

3.3 Measurement Setting Introduction

Please go to measurement page to do measurement settings.



Measurement page

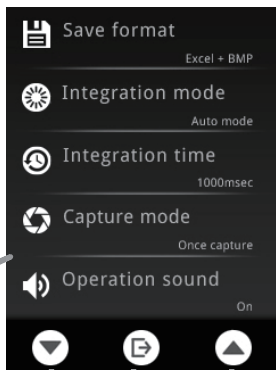

Previous page

Back to measurement page

Next page

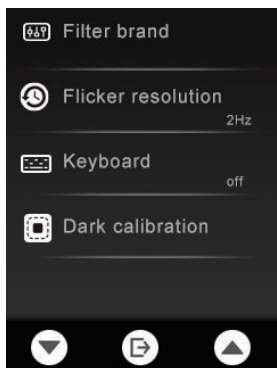

3.3 Measurement Setting Introduction

Save Format Setting :

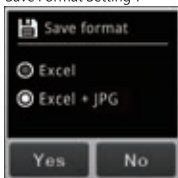

Integration Mode Setting :



Integration Time Setting :



Capture Function Setting :

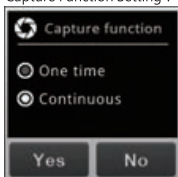

Operation Sound Setting :

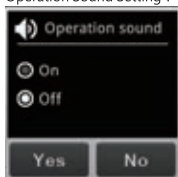

Filter brand Setting :

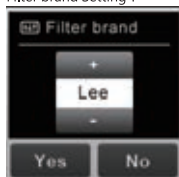

Flicker resolution Setting :

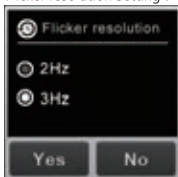

Keyboard Setting :

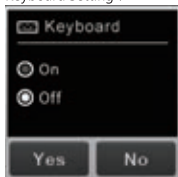

Dark calibration Setting :

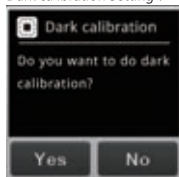

+ / - : Adjust key

Yes / No : End of the setting

3.4 Continuous Measurement Introduction

1

※ View capture function setting, refer 3.3



Select Continuous

2



3

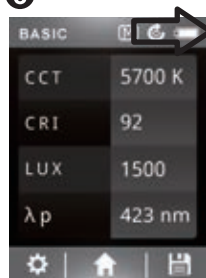

Basic mode
(start measurement)
press capture key



※ The capture symbol
is rotating when CV600
is processing
continuous
measurement.

CV600 will process
measurement with
interval of 3 seconds.

4

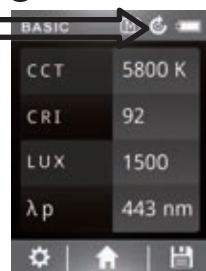

Basic mode
(after measurement)
Press the capture key again to
see the measurement results.

Step 1 : Select the continuous capture.

Step 2 : Press the capture key.

Step 3 : Processing the continuous measurement.

Step 4 : Press capture key again to stop continuous measurement.



1. Continuous measurement has no beep sound after press capture key.
2. Users cannot save the measurement data while processing continuous measurement.
3. Integration time is allowed to be adjusted in the manual mode.

3.5 Customizing BASIC Mode List

The 4 items on the Basic list can be customized with different units of measure (e.g. R1, R9, fc, TLCI).

1



2

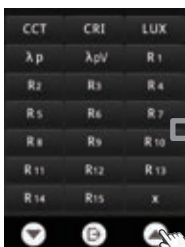

Previous page Back to BASIC mode Next page

3



Step 1 : Tap the box of measuring unit.

Step 2 : Select an item from the list.

Step 3 : The new data item will be displayed.

3.6 CRI Mode

The CRI R1-R15 values of the latest measurement taken.

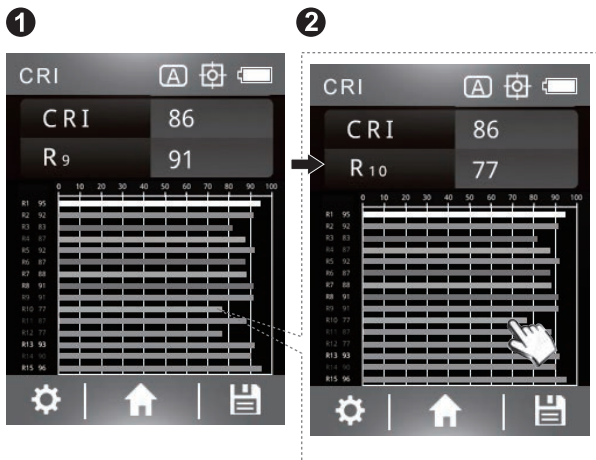

Step 1 : Select the CRI R1-R15 values

Step 2 : The selecting item will be displayed.

3.7 FILTER Mode Introduction

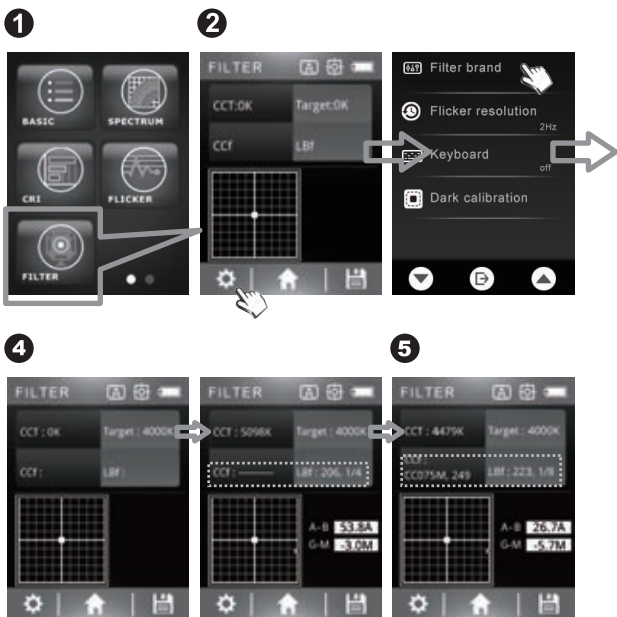

Step 1 : Enter the Filter Mode.

Step 2 : Press the “Set up” button, choose the Filter brand.

Step 3 : Go back to Filter mode, choose the “Target” column to set up the target CCT, press “OK” to finish the setting and go back to Filter mode.

Step 4 : Point to the light source and press the capture key, CCT column displays the current CCT, CCf and LBf columns display the filter number.

3.7 FILTER Mode Introduction

3

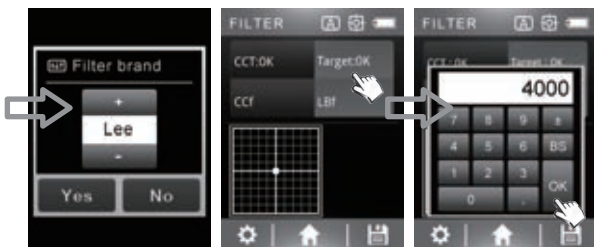

6



Red Point : light source

Central Point : Target

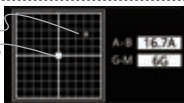

Image Interpretation :

When adjusting the color temperature, You can use this diagram to see whether it is close to the target color temperature, the right hand side display value CCI and LBi. As the example by this diagram, the LBi of the light source is 16.7, the CCT more yellow ; another CCI is 6, the CCT more green. You can use the filter number that recommend by CCF & LBI column to adjust the light source CCT to close 4000K.

Step 5 : Find out the specific filter number and put in front of the light source. Point to the light source again and press the capture key. Please check the difference between the target CCT & actual CCT.

Step 6 : Repeat the Step 4 & 5 to reduce the difference between the target CCT & actual CCT.

3.8 FLICKER Mode

This mode can help user to judge the environment has flicker happened or not. The flicker is "PASS" or "NG" judge by camera FPS(※1) and frequency of environment lighting source.

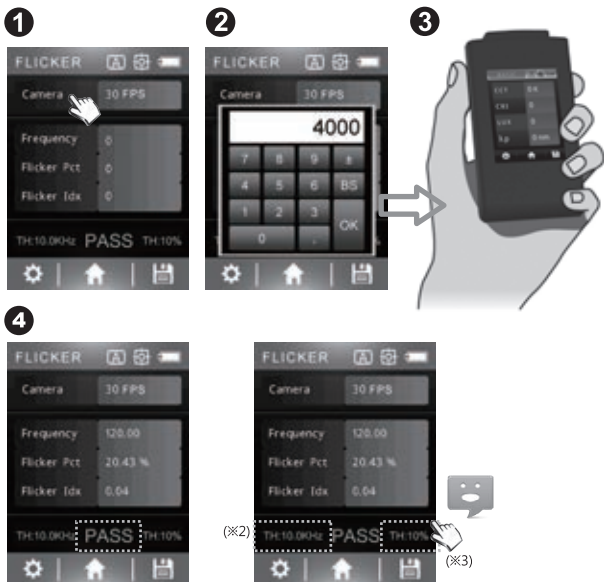

Step 1 : Click on "Camera"

Step 2 : Enter the current using camera FPS.

Step 3 : Point the sensor head at light source and then press the capture key.

Step 4 : The screen will show "PASS/ NG" based on the frequencies relation between camera and light source main frequency.



1. In FLICKER mode main picture, user can input the Lighting TH(※2) in bottom left side.
2. In FLICKER mode main picture, user can input the Intensity TH(※3) in bottom right side.

(※1) FPS : Frame Per Second.

(※2) Lighting Threshold : User can input a lighting frequency based on user experience which means over this lighting frequency is no flicker.

(※3) Intensity Threshold : User can input acceptable intensity limit which means when intensity under this limit is safe.

3.9 FLICKER Mode Judgment Mechanism

1 Determine the PASS area.

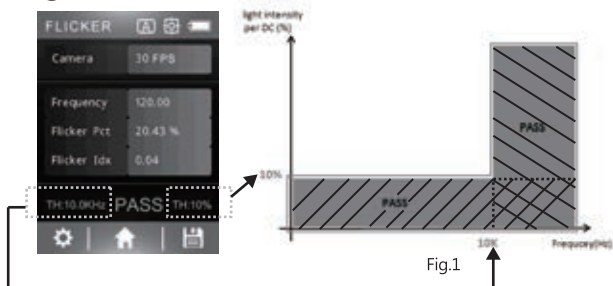

2 Default judgment area.

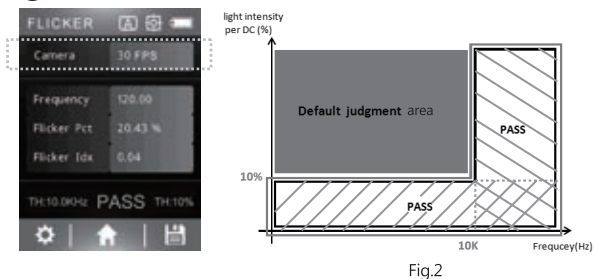

3.9 FLICKER Mode Judgment Mechanism

3 Judge Method

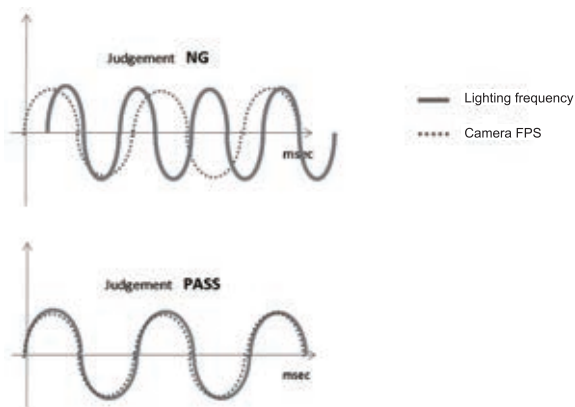
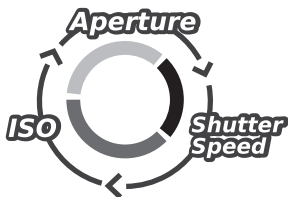

Fig.3

Remark : The flicker judgement will be PASS when lighting frequency is a multiple of the camera FPS.

3.10 EXPOSURE Mode

Give user the information of environmental lux and also determine the relevant relation among shutter, aperture and ISO.



Before you start the measurement, please check the following reference to choose the measuring mode.

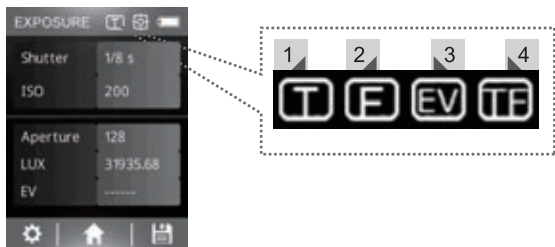

1. T mode : shutter priority & get aperture value.
2. F mode : aperture priority & get shutter value.
3. EV mode : exposure value mode. In this mode, ISO value will be fixed at 100 to measure environmental lux and exposure value.
4. TF mode : shutter/ aperture priority & get ISO value.

3.10 EXPOSURE Mode

T mode

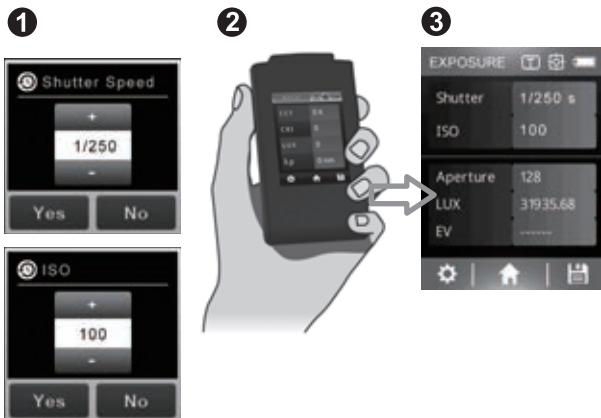

Step 1 : Click on "Shutter" and "ISO" to enter your required values.

Step 2 : Put CV600 at the position where the shooting object will be placed and point sensor head to the light source, then press the measure key

Step 3 : The bottom columns will reveal the values of aperture and lux.

3.10 EXPOSURE Mode

F mode

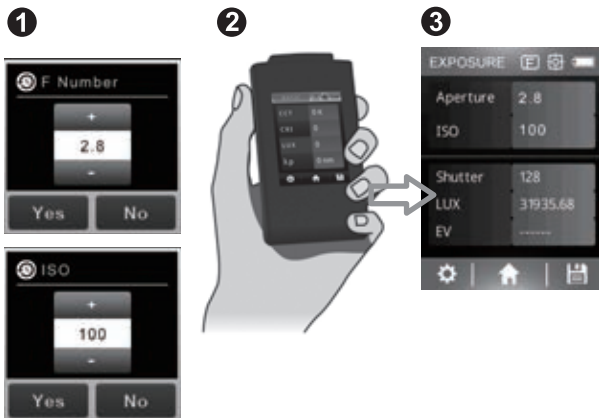

Step 1 : Click on "Aperture" and "ISO" to enter your required values.

Step 2 : Put CV600 at the position where the shooting object will be placed and point sensor head to the light source, then press the measure key

Step 3 : The bottom columns will reveal the values of shutter and lux.

3.10 EXPOSURE Mode

TF mode

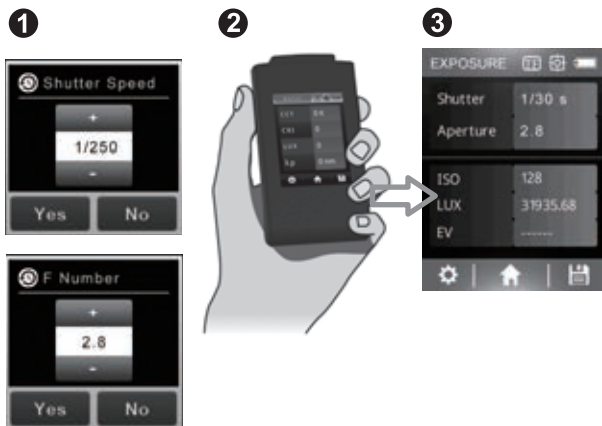

Step 1 : Click on "Shutter" and "Aperture" to enter your required values.

Step 2 : Put CV600 at the position where the shooting object will be placed and point sensor head to the light source, then press the measure key.

Step 3 : The bottom columns will reveal the values of ISO and lux.

3.10 EXPOSURE Mode

EV mode

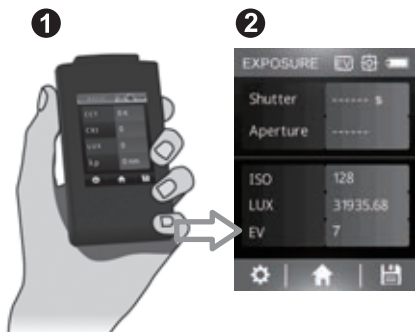

Step 1 : Put CV600 at the position where the shooting object will be placed and point sensor head to the light source, then press the measure key.

Step 2 : The bottom columns will reveal the values of lux and EV.

3.11 BROWSER Mode Introduction

The Browser (on Home Screen) allows you to review historical data that was previously saved to the SD card.

1

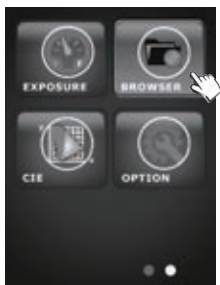

2

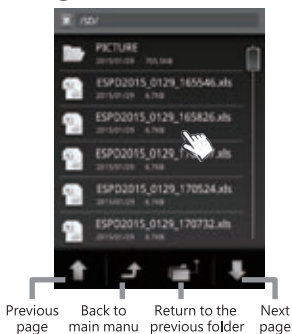

3



Back to
file list

4

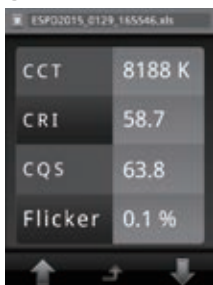

CCT	8188 K
CRI	58.7
CQS	63.8
Flicker	0.1 %

Step 1 : Press the "BROWSER" icon

Step 2 : A file browser will show the files on the SD card.

If you select an excel file, a review menu will be displayed.

Step 3 : Press any of the icons to review the data.

Step 4 : Displaying the data of excel file .

3.12 Transferring Data with PC Connection

Storage the measurement data :

Inside the package has a USB cable, connect the mini USB to CV600 and plug the USB to your PC then you can read the data saved in SD card.

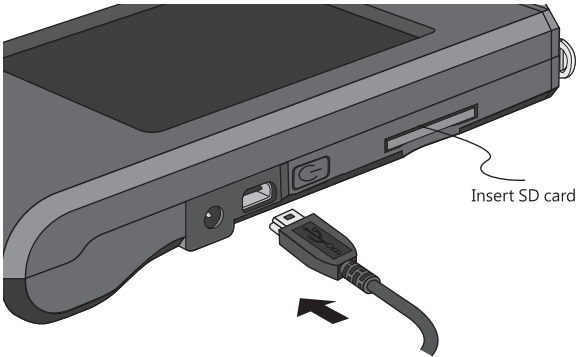

After connected USB cable, CV600 will display as below.





Specification

4

4.1 Product Specification

Sensor	CMOS linear image sensor	
Spectral Bandwidth	Approximately 12 nm (half bandwidth)	
Receptor Size	Ø 6.6 ± 0.1 mm	
Cosine Correction	refer Figure 1.	
Measurement Range	70 ~ 70000 Lux	
Wavelength Range	380 ~ 780 nm	
Flicker sampling rate	100 K/sec	
Capture Function	One time / Continuous	
Integration Mode	Auto / Manual	
Measuring Modes	1. Basic Mode 2. Spectrum Graph Mode 3. CIE Chromaticity Diagram Mode 4. Filter Mode 5. Color Rendering Index Mode 6. Exposure Mode 7. Flicker free Mode	
Measuring Capabilities	1.CCT 2.CRI (Ra) 3.Illuminance / LUX 4.λP 5.λPV 6.CCi, CCf 7.LBi, LBf 8.Delta uv 9.R1 10.R2 11.R3 12.R4 13.R5 14.R6 15.R7 16.R8 17.R9 18.R10 19.R11 20.R12 21.R13 22.R14 23.R15 24.x (CIE 1931) 25.y (CIE 1931) 26.u'(CIE 1976) 27.v'(CIE 1976)	28.Foot Candle 29.Flicker Percentage 30.Flicker Index 31.Frequency 32.I-Time 33.TLCI 34.Spectrum Graphics 35.EV 36.ISO 37.T (shutter) 38.F (aperture)
Digital Resolution	16 bits	
Dark Calibration	Yes	

Stray Light	-25 dB max. ^{*1}	
Wavelength Data Increment	1 nm	
Wavelength Reproducibility	± 1 nm ^{*2}	
Illuminance Accuracy	Illuminant A @ 2856K at 20000 Lux	± 5%
Color Accuracy		± 0.0025 in CIE 1931 x,y
Color Repeatability		± 0.0005 in CIE 1931 x,y
CCT Accuracy		± 2%
CRI Accuracy @ Ra		± 1.5%
Display	3.5" LCD 320X240 Touch Panel	
Max. Files	≈ 2000 Files @ 2GB SD Card	
Battery Operation Time	≤ 5 hours / Fully Charged	
Battery	2500 mAh / Rechargeable Li-ion Battery	
Data Output Interface	SD Card (SD2.0, SDHC/above 1GB~up to 32GB) / USB 2.0	
Data Format	Compatible Excel / JPG Data Format	
Dimensions	144.2 x 78 x 24 mm (H x W x D)	
Weight(with Battery)	250 g ± 20 g	
Operating Temperature	0 ~ 35 °C	
Storage Temperature	-10 ~ 40 °C	
Language Selection	English / Traditional Chinese / Simplified Chinese / Japanese / Spanish / German / French / Italian / Russian	
<p>*1 : Use the input of 550nm single-frequency and measurement the range of optical ± 40nm.</p> <p>*2 : Input source must be a stable light source.</p> <p>The company reserves the right to change product specifications, if it has any changes will not give any notice.</p>		

Figure 1 : Cosine Correction

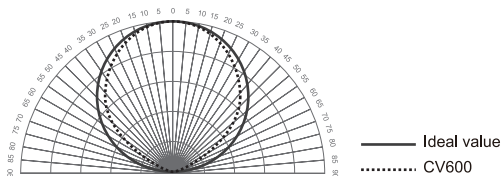



Appendix Warranty

5

5.1 Product Warranty

5.1 Product Warranty

Warranty Policy

UPRtek provides replacement or repair services to our customers for defective products within the applicable warranty period.

1. DOA (Dead on Arrival) Returns :

- In the event that you receive a product that is not working properly or is defective, you should notify our service staff upon receipt of the products. If defects in the product are discovered within 7 days after receiving the product (except those due to willful damage or customer misuse), you should notify us by email, facsimile, or phone immediately upon noticing the defect, so we can process the return as a DOA product. You will be issued a DOA number accordingly.
- DOA products must be returned within 30 days of purchase and in original condition. For products considered as “Dead on Arrival” , we will replace it with a new product (in whole package) at no charge and pay return and re-delivery shipping costs. International customers should allow for additional transit time due to international customs clearance.

2. RMA (Return Merchandise Authorization) :

- For merchandise sent for repair or replacement with or without warranty, you must first obtain an RMA number by contacting our service staff by mail. The following information is required in order to complete your RMA request: company name, contact person, phone number and e-mail, customer ship-to address, product model number, serial number, and a brief description of the problem you are experiencing with the product you wish to return.
- All returned products will be tested by our professional technicians to verify the complaint / defect in question. However, if the defect in question cannot be found by our technicians, you are responsible for paying a testing fee plus shipping fee for NDF (No-Defect Found) products.
- Claims for loss or damage during shipment must be made to the courier by the customer. For your protection, we strongly recommend that you fully insure your return shipment for damages. Please use a courier that is able to provide you with proof of delivery.

Limitation of Warranty

Please note that UPRtek is not responsible for providing repairs under warranty if the product defect is caused by any of the following factors :

1. Damage caused by natural calamity or any inappropriate usage.

5.1 Product Warranty

2. Product has been repaired or taken apart by unauthorized technicians.
3. The warranty label is altered, damaged or missing.
4. Product serial number does not conform to our original system or the label has been damaged.

Disclaimer

- UPRtek shall in no event be liable for any defect, damage or data loss that has occurred during the delivery of in-warranty products. Prior to claiming warranty service, UPRtek recommends that you make a backup of your data and remove your data from in-warranty products.
- Under the maximum allowable range of applicable laws and regulations, any business loss, expected cost loss, data disappearance, or any other indirect, accidental, or derived loss or damages due to the utilization of or related to the company product, shall not be the responsibility of UPRtek for any compensation.

Customers Eligible for Warranty Service

UPRtek warranty policy applies to all customers who purchased from either UPRtek or through authorized agents of UPRtek.

Duration of Warranty

1. CV600 HOST :

The CV600 LED METER all come with a 2-year product warranty.

2. Accessories :

UPRtek RMA policy is only for LED Meter repair and does not cover maintenance or calibration services. The policy also does not cover accessories like tripods and straps, nor does it cover consumable items like batteries.

Authorized Distributor/Dealer Services

- **Product-based functional testing** - Performed by distributors and dealers to determine whether the product needs to be returned to the factory for further calibration services or technical repairs (All UPRtek authorized distributors/dealers have a right to perform "Product-based functional testing" for a reasonable charge).
- **RMA product delivery to and from factory** - Distributors/dealers can assist customers in sending/receiving RMA products to/from the UPRtek factory.

5.1 Product Warranty

- Authorized distributors/dealers are listed on our website : www.uprtek.com

Additional Remarks

Product parts and components are not always manufactured by UPRtek. On occasion, these 3rd party components may need to be replaced but are already discontinued by the supplier. In this case, UPRtek assures customers that it will fulfill its repair and replacement responsibilities by using substitute parts or components of equal level and quality.

Delivery Methods

Consumers can choose either of the two methods indicated below to return the product to the factory for RMA Service :

- Customers can send the products through UPRtek global distribution channels that will send and return the products to and from the factory for repair and warranty service.
- Customers can return the product directly to the UPRtek factory for servicing.

Rules on Product Repairs After The Warranty Period

UPRtek provides product services after warranty expiration at reasonable charges. In case of product defects, the customers are still able to send products back to the UPRtek factory for service. The repair charges will be based on the type of defect, and in some cases, maintenance fees will be charged.

However, purchasing a new product is advised under these conditions:

- If the CV600 or its accessories are no longer available.
- If the product functionality is almost certain to be impossible to recover from (e.g. total immersion in water, undergoing extreme electrical shock, severe contamination or corrosion damage).
- If the product was dropped or sustained such a traumatic impact causing major structural damage, or if our technicians determine that normal functionality cannot be recovered even after major component replacement.
- If multiple parts simultaneously fail due to normal wear and tear, or poor handling.
- Even if the product is within the service period of the warranty, yet parts are no longer available.



uSPECTRUM PC Software

Download File

www.uprtek.com → [Membership](#) → [Login](#) → [Support](#) → [Download Center](#)

* To ensure your warranty validation, please place your agent's stamp in the box and fill in the purchase date. If the agent stamp and purchase date cannot be supplied, the warranty period will be based on the manufacturing date of the product.

Original / Authorized Agent Stamp

Product Serial Number : _____

Purchase Date : _____

Catalog Date: C1604 Printed in Taiwan

52-72-00012-0000

UPRtek 群耀科技股份有限公司
United Power Research Technology Corporation

☎ +886-37-580-885 ☎ +886-37-580-398 🌐 www.UPRtek.com ✉ sales@uprtek.com

📍 No.38, Keyi Street, Zhunan Township, Miaoli County 35059, Taiwan